

## N-Channel Super Junction Power MOSFET

### Features

- New technology for high voltage device
- Low on-resistance and low conduction losses
- small package
- Ultra Low Gate Charge cause lower driving requirements
- 100% Avalanche Tested
- ROHS compliant

### Application

- Power factor correction (PFC)
- Switched mode power supplies(SMPS)
- Uninterruptible Power Supply (UPS)

$V_{DS}$	650	V
$R_{DS(ON)TYP}$	300	m $\Omega$
$I_D$	11.5	A

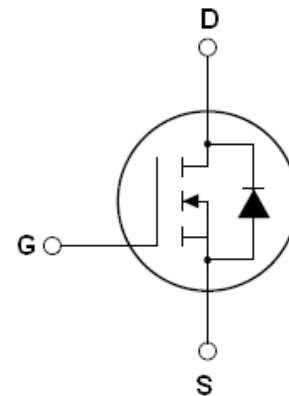

Schematic diagram

### Package Marking And Ordering Information

Device	Device Package	Marking
SL11N65CK	TO-263	SL11N65CK
SL11N65C	TO-220	SL11N65C
SL11N65CF	TO-220F	SL11N65CF

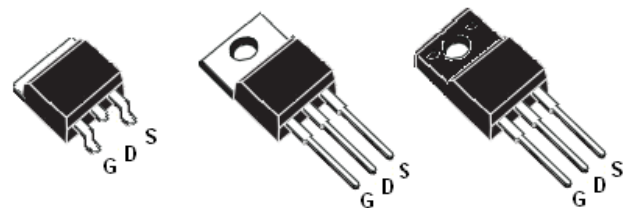

TO-263

TO-220

TO-220F

Table 1. Absolute Maximum Ratings ( $T_C=25^\circ\text{C}$ )

Parameter	Symbol	SL11N65CK SL11N65C	SL11N65CF	Unit
Drain-Source Voltage ( $V_{GS}=0V$ )	$V_{DS}$	650		V
Gate-Source Voltage ( $V_{DS}=0V$ ), AC( $f>1\text{HZ}$ )	$V_{GS}$	$\pm 30$		V
Continuous Drain Current at $T_C=25^\circ\text{C}$	$I_{D(DC)}$	11.5	11.5*	A
Continuous Drain Current at $T_C=100^\circ\text{C}$	$I_{D(DC)}$	7	7*	A
Pulsed drain current (Note 1)	$I_{DM(pluse)}$	46	46*	A
Maximum Power Dissipation( $T_C=25^\circ\text{C}$ ) Derate above $25^\circ\text{C}$	$P_D$	101 0.81	32.6 0.26	W W/ $^\circ\text{C}$
Single pulse avalanche energy (Note2)	$E_{AS}$	144		mJ
Avalanche current (Note 1)	$I_{AR}$	6		A
Repetitive Avalanche energy , $t_{AR}$ limited by $T_{jmax}$ (Note 1)	$E_{AR}$	0.5		mJ

Parameter	Symbol	SL11N65CK SL11N65C	SL11N65CF	Unit
Drain Source voltage slope, $V_{DS} \leq 480V$ ,	dv/dt	50		V/ns
Reverse diode dv/dt, $V_{DS} \leq 480V, I_{SD} < I_D$	dv/dt	15		V/ns
Operating Junction and Storage Temperature Range	$T_J, T_{STG}$	-55...+150		°C

\* limited by maximum junction temperature

**Table 2. Thermal Characteristic**

Parameter	Symbol	SL11N65CK SL11N65C	SL11N65CF	Unit
Thermal Resistance, Junction-to-Case (Maximum)	$R_{thJC}$	1.24	3.83	°C/W
Thermal Resistance, Junction-to-Ambient (Maximum)	$R_{thJA}$	62	80	°C/W

**Table 3. Electrical Characteristics (TA=25°C unless otherwise noted)**

Parameter	Symbol	Condition	Min	Typ	Max	Unit
<b>On/off states</b>						
Drain-Source Breakdown Voltage	$BV_{DSS}$	$V_{GS}=0V, I_D=250\mu A$	650			V
Zero Gate Voltage Drain Current(Tc=25°C)	$I_{DSS}$	$V_{DS}=650V, V_{GS}=0V$		0.05	1	μA
Zero Gate Voltage Drain Current(Tc=125°C)	$I_{DSS}$	$V_{DS}=650V, V_{GS}=0V$			100	μA
Gate-Body Leakage Current	$I_{GSS}$	$V_{GS}=\pm 20V, V_{DS}=0V$			±100	nA
Gate Threshold Voltage	$V_{GS(th)}$	$V_{DS}=V_{GS}, I_D=250\mu A$	3	3.5	4	V
Drain-Source On-State Resistance	$R_{DS(on)}$	$V_{GS}=10V, I_D=7A$		300	360	mΩ
<b>Dynamic Characteristics</b>						
Input Capacitance	$C_{iss}$	$V_{DS}=50V, V_{GS}=0V,$ $F=1.0MHz$		870		pF
Output Capacitance	$C_{oss}$			54		pF
Reverse Transfer Capacitance	$C_{rss}$			1.8		pF
Total Gate Charge	$Q_g$	$V_{DS}=480V, I_D=11.5A,$ $V_{GS}=10V$		19		nC
Gate-Source Charge	$Q_{gs}$			6		nC
Gate-Drain Charge	$Q_{gd}$			6.5		nC
<b>Switching times</b>						
Turn-on Delay Time	$t_{d(on)}$	$V_{DD}=380V, I_D=5.5A,$ $R_G=3\Omega, V_{GS}=10V$		11		nS
Turn-on Rise Time	$t_r$			8		nS
Turn-Off Delay Time	$t_{d(off)}$			58	70	nS
Turn-Off Fall Time	$t_f$			9	14	nS
<b>Source- Drain Diode Characteristics</b>						
Source-drain current(Body Diode)	$I_{SD}$	$T_C=25^\circ C$			11.5	A
Pulsed Source-drain current(Body Diode)	$I_{SDM}$				46	A
Forward on voltage	$V_{SD}$	$T_J=25^\circ C, I_{SD}=11.5A, V_{GS}=0V$		0.9	1.2	V
Reverse Recovery Time	$t_{rr}$	$T_J=25^\circ C, I_F=5.8A,$ $di/dt=100A/\mu s$		220		nS
Reverse Recovery Charge	$Q_{rr}$			2.2		uC
Peak Reverse Recovery Current	$I_{rrm}$			19		A

Notes: 1.Repetitive Rating: Pulse width limited by maximum junction temperature

2.  $T_J=25^\circ C, V_{DD}=50V, V_G=10V, R_G=25\Omega$

## TYPICAL ELECTRICAL AND THERMAL CHARACTERISTICS (curves)

**Figure1. Safe operating area**

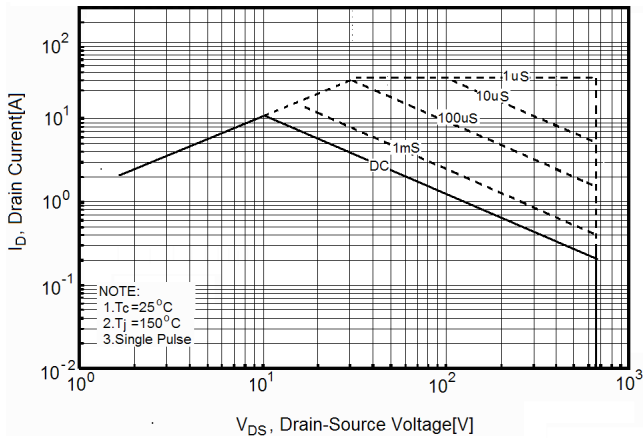

**Figure2. Safe operating area for TO-220F**

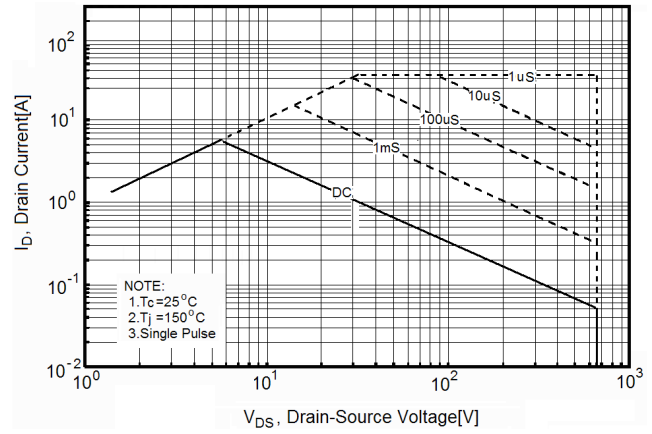

**Figure3. Source-Drain Diode Forward Voltage**

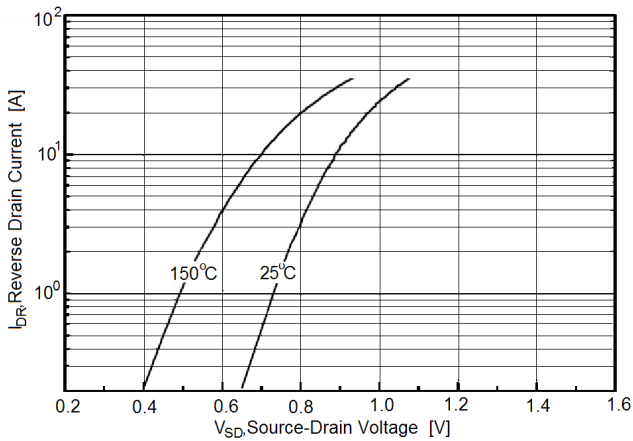

**Figure4. Output characteristics**

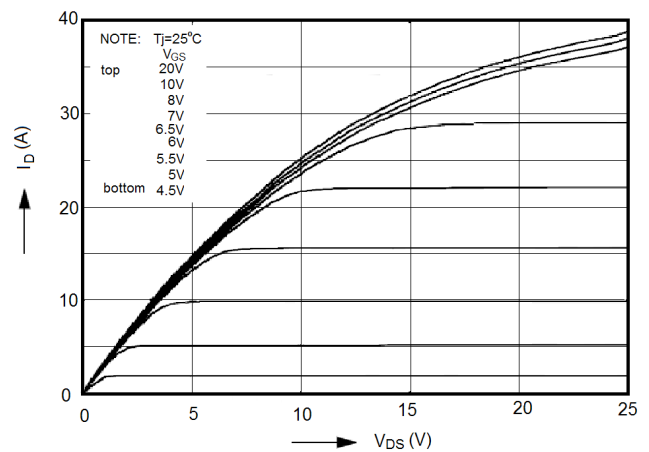

**Figure5. Transfer characteristics**

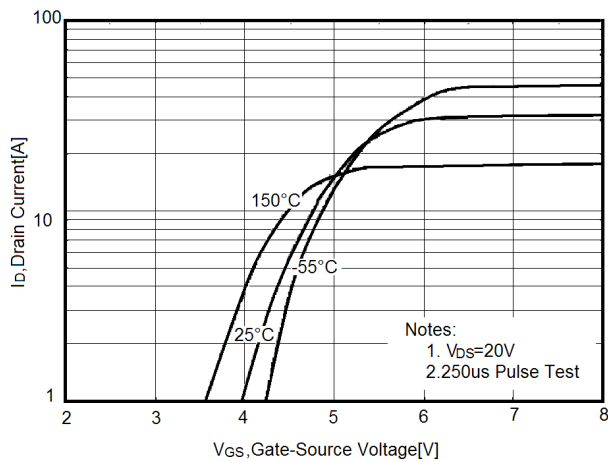

**Figure6. Static drain-source on resistance**

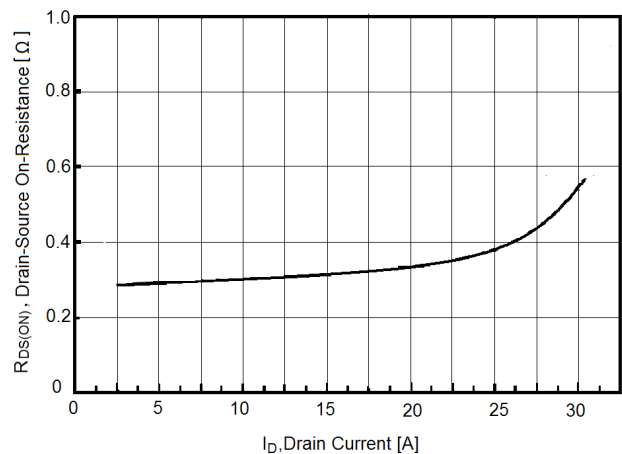

**Figure7.  $R_{DS(on)}$  vs Junction Temperature**

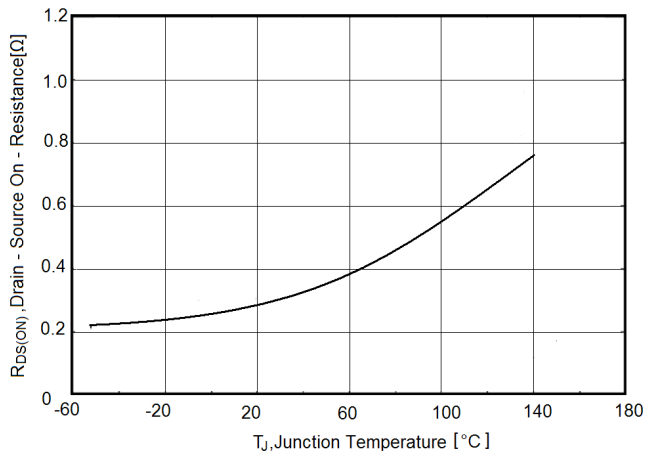

**Figure8.  $BV_{DSS}$  vs Junction Temperature**

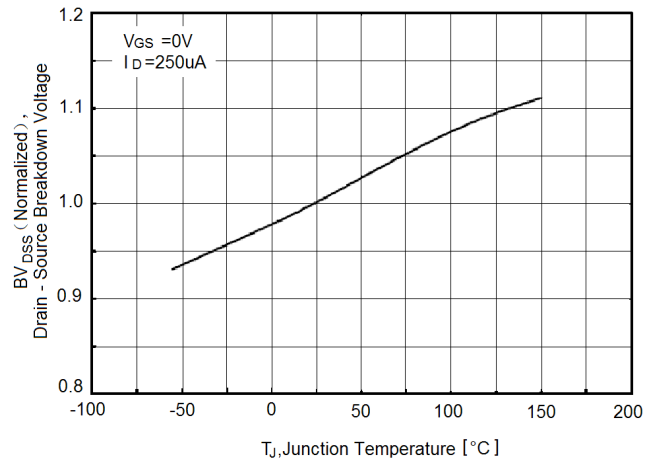

**Figure9. Maximum  $I_D$  vs Junction Temperature**

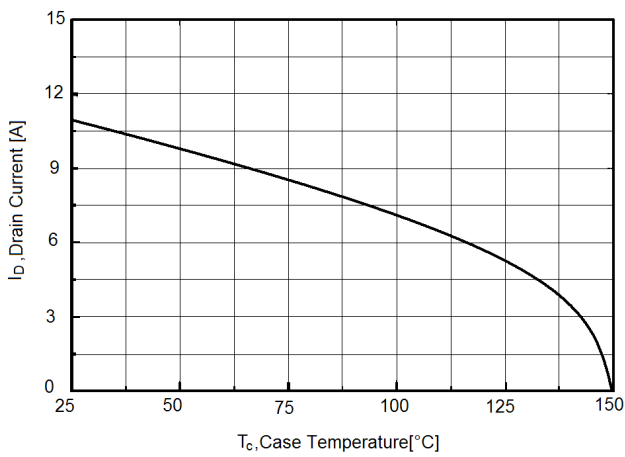

**Figure10. Gate charge waveforms**

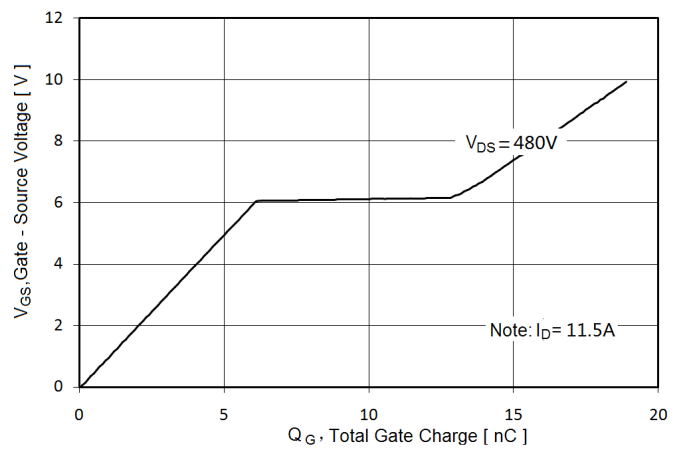

**Figure11. Capacitance**

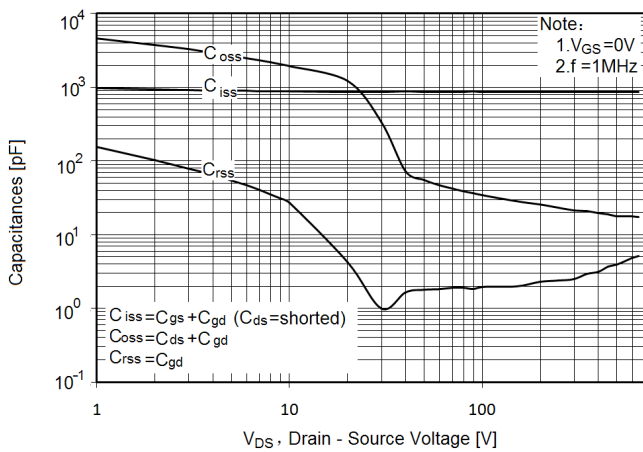

**Figure12. Transient Thermal Impedance**

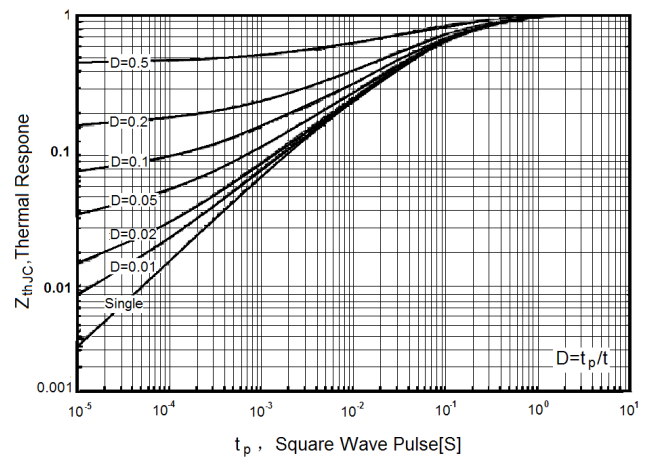
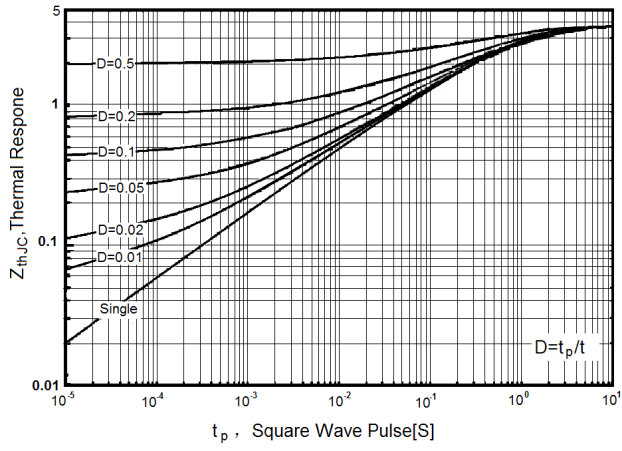
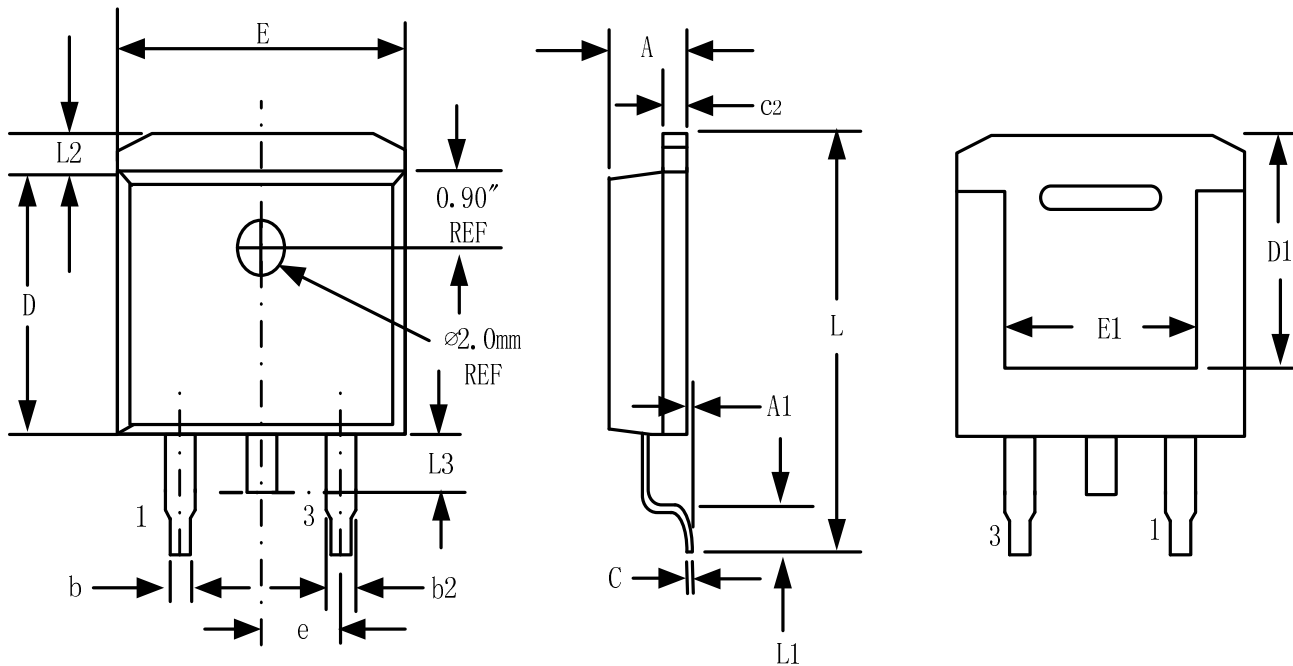

Figure13. Transient Thermal Impedance for TO-220F



## TO-263-3L Package Information

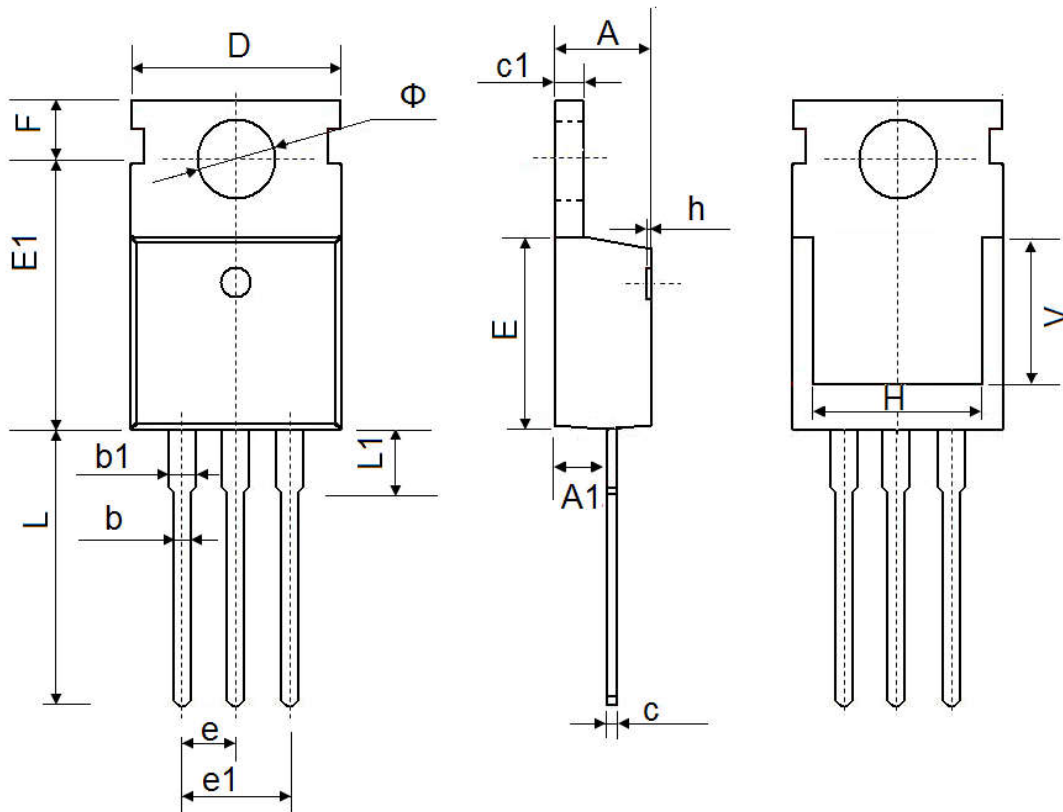

Symbol	Dimensions In Millimeters		Dimensions In Inches	
	Min.	Max.	Min.	Max.
A	4.32	4.57	0.170	0.180
A1	-	0.25		0.010
b	0.71	0.94	0.028	0.037
b2	1.15	1.40	0.045	0.055
c	0.46	0.61	0.018	0.024
c2	1.22	1.40	0.048	0.055
D	8.89	9.40	0.350	0.370
D1	8.01	8.23	0.315	0.324
E	10.04	10.28	0.395	0.405
E1	7.88	8.08	0.310	0.318
e	2.54 BSC		0.100 BSC	
L	14.73	15.75	0.580	0.620
L1	2.29	2.79	0.090	0.110
L2	1.15	1.39	0.045	0.055
L3	1.27	1.77	0.050	0.070

**TO-220-3L-C Package Information**

Symbol	Dimensions In Millimeters		Dimensions In Inches	
	Min.	Max.	Min.	Max.
A	4.400	4.600	0.173	0.181
A1	2.250	2.550	0.089	0.100
b	0.710	0.910	0.028	0.036
b1	1.170	1.370	0.046	0.054
c	0.330	0.650	0.013	0.026
c1	1.200	1.400	0.047	0.055
D	9.910	10.250	0.390	0.404
E	8.9500	9.750	0.352	0.384
E1	12.650	12.950	0.498	0.510
e	2.540 TYP.		0.100 TYP.	
e1	4.980	5.180	0.196	0.204
F	2.650	2.950	0.104	0.116
H	7.900	8.100	0.311	0.319
h	0.000	0.300	0.000	0.012
L	12.900	13.400	0.508	0.528
L1	2.850	3.250	0.112	0.128
V	7.500 REF.		0.295 REF.	
Φ	3.400	3.800	0.134	0.150

## TO-220F Package Information

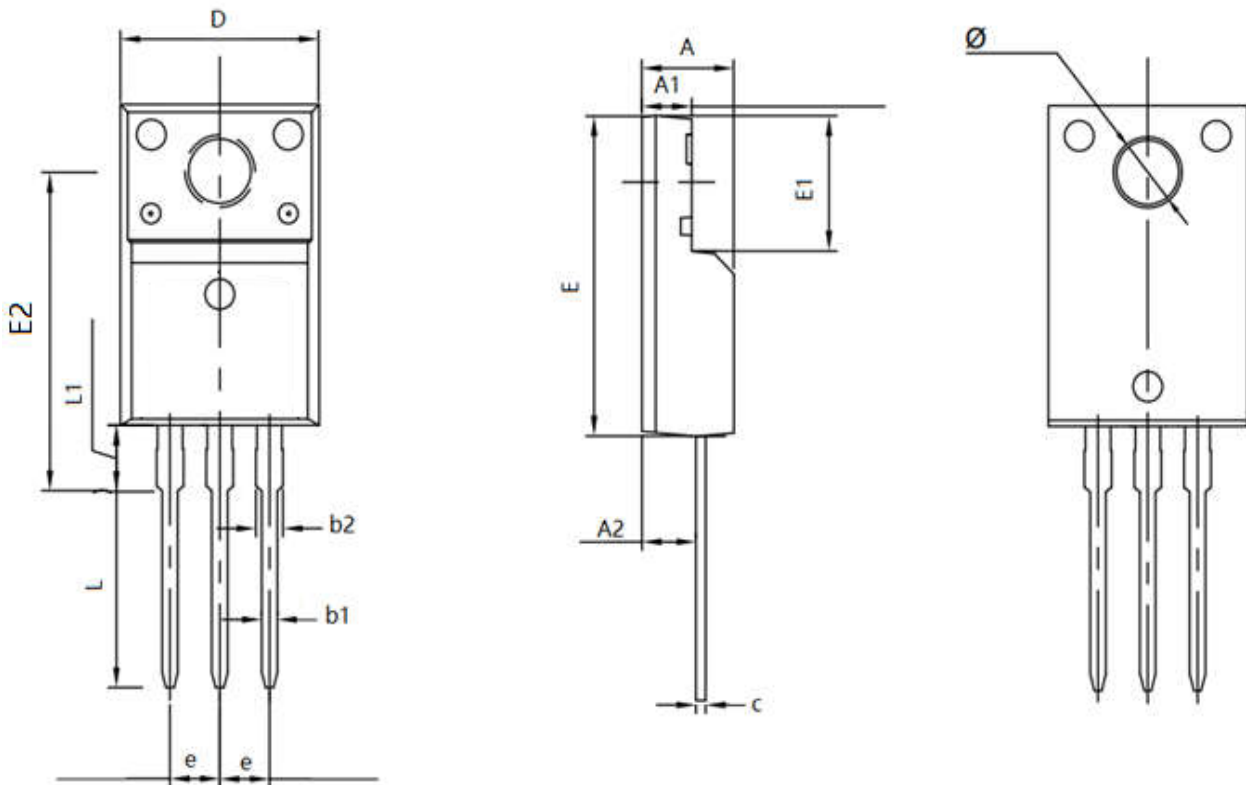

Symbol	Dimensions In Millimeters		Dimensions In Inches	
	Min.	Max.	Min.	Max.
A	4.500	4.900	0.177	0.193
A1	2.340	2.740	0.092	0.108
A2	2.560	2.960	0.101	0.117
b1	0.700	0.900	0.028	0.035
b2	1.180	1.580	0.046	0.062
c	0.400	0.600	0.016	0.024
D	9.960	10.360	0.392	0.408
E	15.670	15.970	0.617	0.629
E1	6.500	6.900	0.256	0.272
E2	15.500	16.100	0.610	0.634
e	2.540 TYP		0.100 TYP	
Φ	3.080	3.280	0.121	0.129
L	12.640	13.240	0.498	0.521
L1	3.030	3.430	0.119	0.135