

GaAs Hall Element

Absolute Maximum Ratings

Item	Symbol	Conditions	Limit	Unit
Max. Input Voltage	V_C	$T_a=25^\circ\text{C}$	5	V
Max. Input Power	P_D		25	mW
Operating Temp. Range	T_{opr}		-40 ~ +125	$^\circ\text{C}$
Storage Temp. Range	T_{STG}		-45 ~ +150	$^\circ\text{C}$

Electrical Characteristics ($T_a=25^\circ\text{C}$)

Item	Symbol	Conditions	Min.	Typ.	Max.	Unit
Output Hall Voltage	V_H^{**}	$B=50\text{mT}, I_c=5\text{mA}$	36	45	54	mV
Input Resistance	R_{in}	$B=0\text{mT}, I_c=0.1\text{mA}$	650	750	850	Ω
Output Resistance	R_{out}	$B=0\text{mT}, I_c=0.1\text{mA}$	650	750	850	Ω
Offset Voltage	$V_{OS}(V_u)$	$B=0\text{mT}, I_c=5\text{mA}$	-5		+5	mV
Temp. Coefficient of V_H	αV_H^{**}	$B=50\text{mT}, I_c=5\text{mA}$ $T_a=25\sim 125^\circ\text{C}$			0.06	$\% / ^\circ\text{C}$
Temp. Coefficient of R_{in}	αR_{in}^{**}	$B=0\text{mT}, I_c=0.1\text{mA}$ $T_a=25\sim 125^\circ\text{C}$			0.3	$\% / ^\circ\text{C}$
Linearity	ΔK^{**}	$B=0.1/0.5\text{T}, I_c=5\text{mA}$	-1		+1	%

Notes : 1. $V_H = V_{HM} - V_{OS}(V_u)$ (VHM: meter indication)

$$2. \alpha V_H = \frac{1}{V_H(T_1)} \times \frac{V_H(T_2) - V_H(T_1)}{(T_2 - T_1)} \times 100$$

$$3. \alpha R_{in} = \frac{1}{R_{in}(T_1)} \times \frac{R_{in}(T_2) - R_{in}(T_1)}{(T_2 - T_1)} \times 100$$

$$4. \Delta K = \frac{K(B_1) - K(B_2)}{[K(B_1) + K(B_2)] / 2} \times 100$$

$$T_1 = 25^\circ\text{C}, T_2 = 125^\circ\text{C}$$

$$K = \frac{V_H}{I_c \cdot B}$$

$$B_1 = 0.5\text{T}, B_2 = 0.1\text{T}$$

Characteristic Curves

Allowable Package Power Dissipation

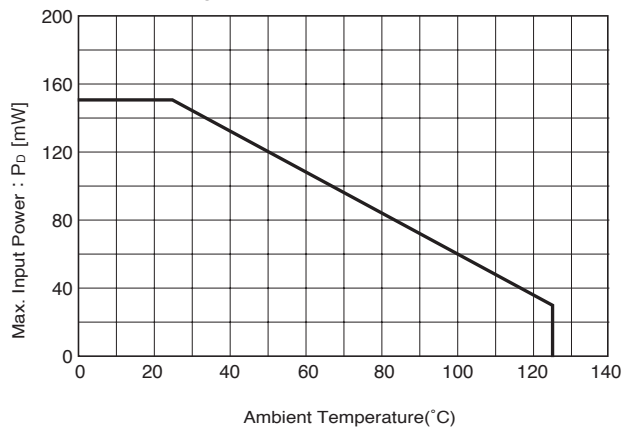

Dimensional Drawing (Unit : mm)

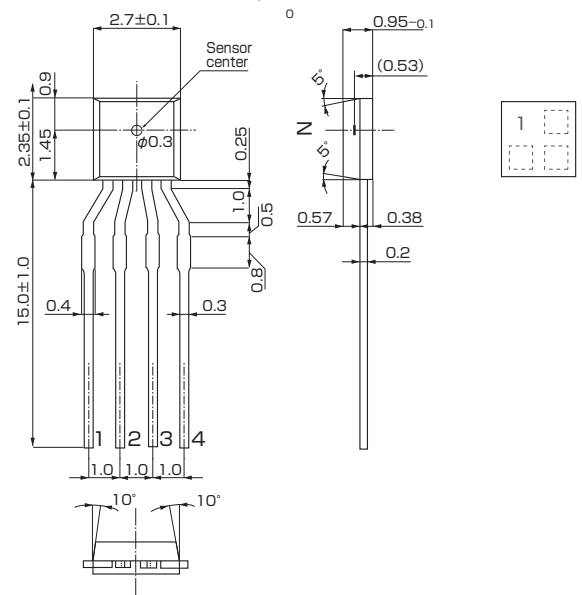

Pinning

1 (+) - 3 (-) (Input)

2 (+) - 4 (-) (Output)

● Characteristic Curves

R_{in}-T

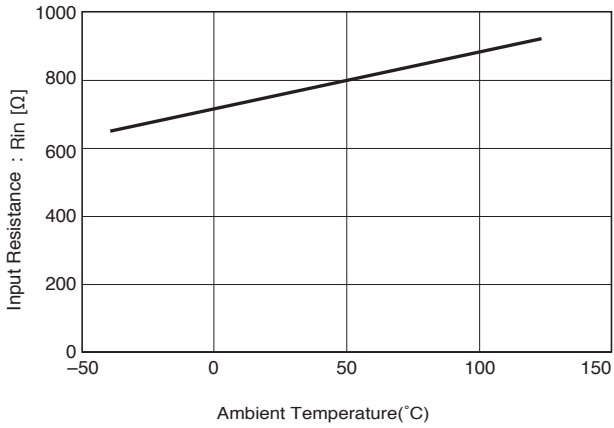

V_H-B

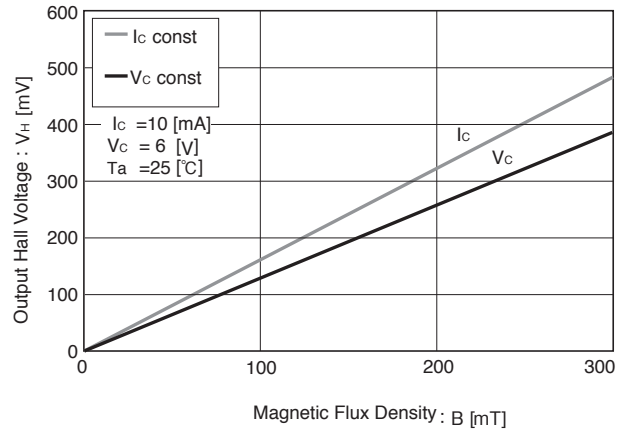

V_H-T

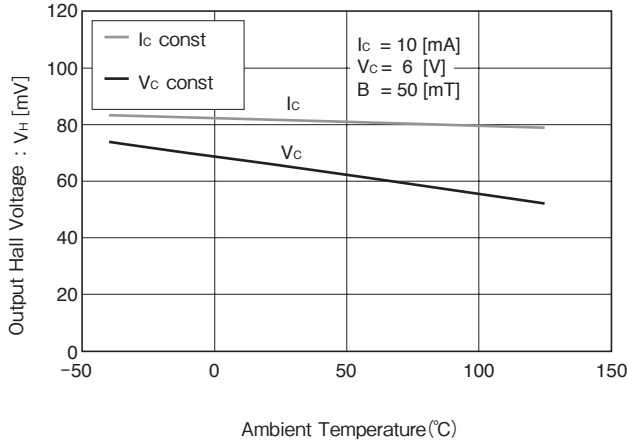

V_H-V_c, V_H-I_c

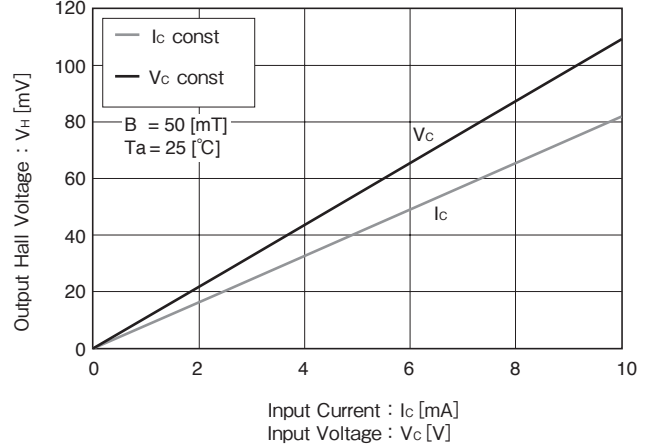

V_{os} (V_u)-T

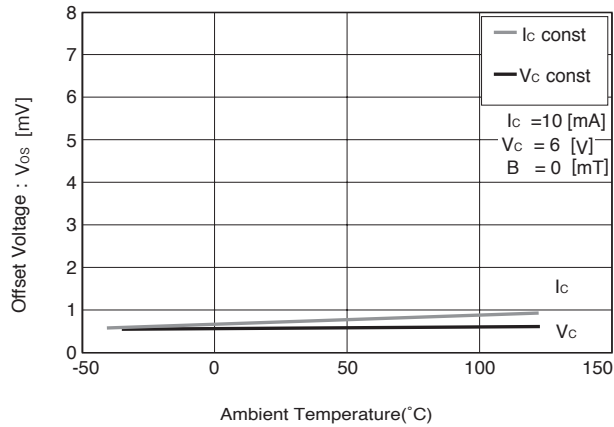

※Magnetic Flux Density
 1[mT]=10 [G]

V_{os} (V_u)-V_c, V_{os} (V_u)-I_c

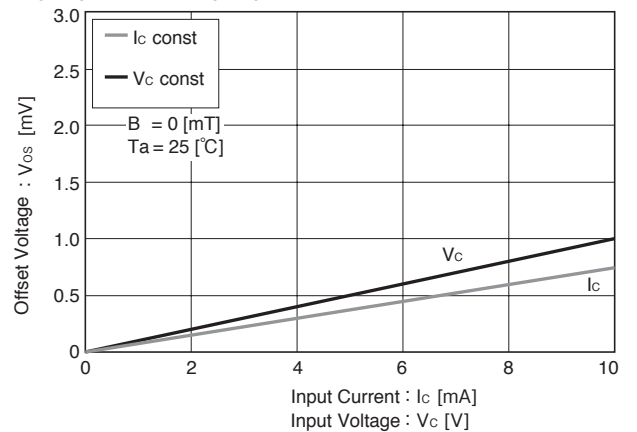

$R_{in} = 750$ [Ω], $V_{os} = 0.6$ [mV] ($V_c = 6$ [V])
 In This Example : $R_{in} = 750$ [Ω], $V_{os} = 0.6$ [mV], ($V_c = 6$ [V])