

## P-Channel Power MOSFET

### General Features

- $V_{DS} = -20V, I_D = -4A$   
 $R_{DS(ON)} < 60m\Omega @ V_{GS} = -2.5V$   
 $R_{DS(ON)} < 50m\Omega @ V_{GS} = -4.5V$
- High Power and current handing capability
- Lead free product is acquired
- Surface mount package

### Application

- PWM application
- Load switch

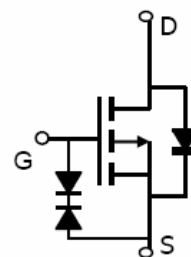

Schematic diagram

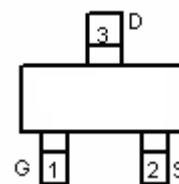

Marking and pin Assignment



SOT-23 top view

### Absolute Maximum Ratings (TA=25°C unless otherwise noted)

Parameter	Symbol	Limit	Unit
Drain-Source Voltage	$V_{DS}$	-20	V
Gate-Source Voltage	$V_{GS}$	±8	V
Drain Current-Continuous	$I_D$	-4	A
Drain Current-Pulsed (Note 1)	$I_{DM}$	-30	A
Maximum Power Dissipation	$P_D$	1.5	W
Operating Junction and Storage Temperature Range	$T_J, T_{STG}$	-55 To 150	°C

### Thermal Characteristic

Thermal Resistance, Junction-to-Ambient (Note 2)	$R_{\theta JA}$	357	°C/W
--	-----------------	-----	------

### Electrical Characteristics (TA=25°C unless otherwise noted)

Parameter	Symbol	Condition	Min	Typ	Max	Unit
<b>Off Characteristics</b>						
Drain-Source Breakdown Voltage	$BV_{DSS}$	$V_{GS} = 0V, I_D = -250\mu A$	-20		-	V

Zero Gate Voltage Drain Current	$I_{DSS}$	$V_{DS}=-20V, V_{GS}=0V$	-	-	1	$\mu A$
Gate-Body Leakage Current	$I_{GSS}$	$V_{GS}=\pm 10V, V_{DS}=0V$	-	-	$\pm 10$	$\mu A$
<b>On Characteristics (Note 3)</b>						
Gate Threshold Voltage	$V_{GS(th)}$	$V_{DS}=V_{GS}, I_D=-250\mu A$	-0.3	-0.65	-1	V
Drain-Source On-State Resistance	$R_{DS(ON)}$	$V_{GS}=-4.5V, I_D=-4A$	-	33	50	m $\Omega$
		$V_{GS}=-2.5V, I_D=-4A$	-	45	60	m $\Omega$
Forward Transconductance	$g_{FS}$	$V_{DS}=-5V, I_D=-4A$	8	-	-	S
<b>Dynamic Characteristics (Note4)</b>						
Input Capacitance	$C_{iss}$	$V_{DS}=-10V, V_{GS}=0V,$ $F=1.0MHz$	-	1450	-	PF
Output Capacitance	$C_{oss}$		-	205	-	PF
Reverse Transfer Capacitance	$C_{rss}$		-	160	-	PF
<b>Switching Characteristics (Note 4)</b>						
Turn-on Delay Time	$t_{d(on)}$	$V_{DD}=-10V, R_L=2.5\Omega$ $V_{GS}=-4.5V, R_{GEN}=3\Omega$	-	9.5		nS
Turn-on Rise Time	$t_r$		-	17		nS
Turn-Off Delay Time	$t_{d(off)}$		-	94		nS
Turn-Off Fall Time	$t_f$		-	35		nS
Total Gate Charge	$Q_g$	$V_{DS}=-10V, I_D=-4A,$ $V_{GS}=-4.5V$	-	17.2		nC
Gate-Source Charge	$Q_{gs}$		-	1.3	-	nC
Gate-Drain Charge	$Q_{gd}$		-	4.5	-	nC
<b>Drain-Source Diode Characteristics</b>						
Diode Forward Voltage (Note 3)	$V_{SD}$	$V_{GS}=0V, I_S=-1A$	-	-	-1	V
Diode Forward Current (Note 2)	$I_S$		-	-	-4	A

**Notes:**

1. Repetitive Rating: Pulse width limited by maximum junction temperature.
2. Surface Mounted on FR4 Board,  $t \leq 10$  sec.
3. Pulse Test: Pulse Width  $\leq 300\mu s$ , Duty Cycle  $\leq 2\%$ .
4. Guaranteed by design, not subject to production

**Typical Electrical and Thermal Characteristics**

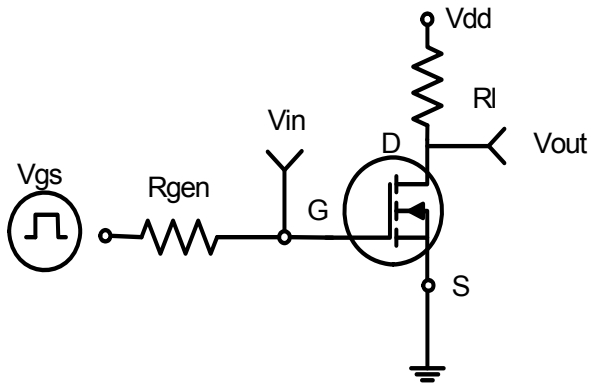

**Figure 1: Switching Test Circuit**

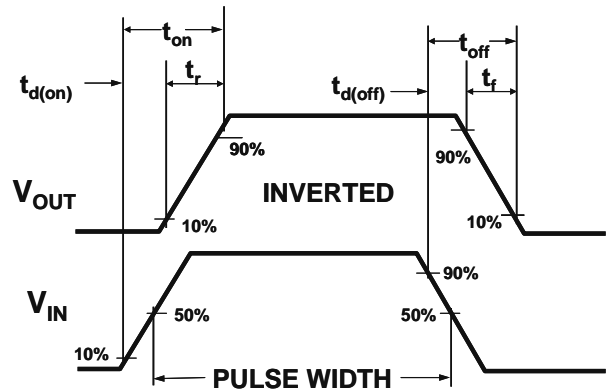

**Figure 2: Switching Waveforms**

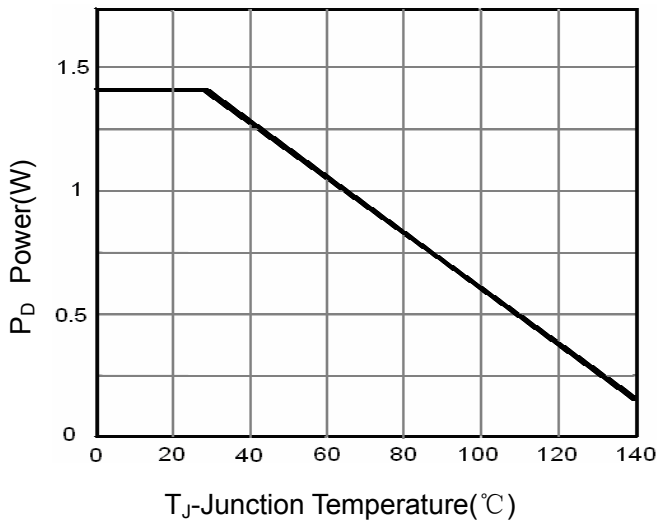

**Figure 3 Power Dissipation**

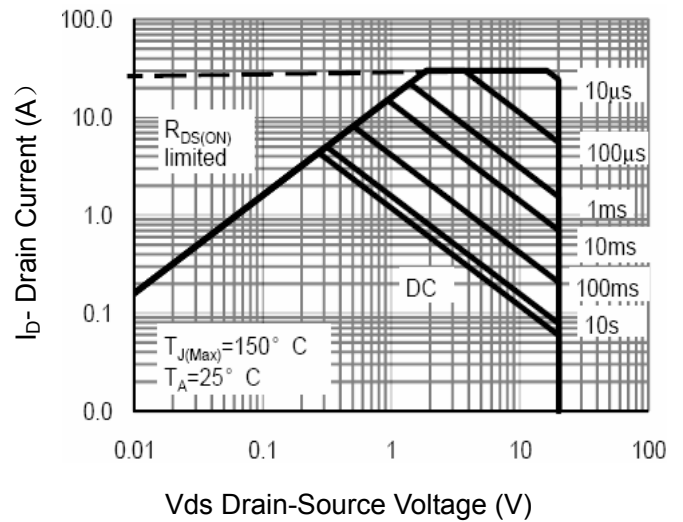

**Figure 4 Safe Operation Area**

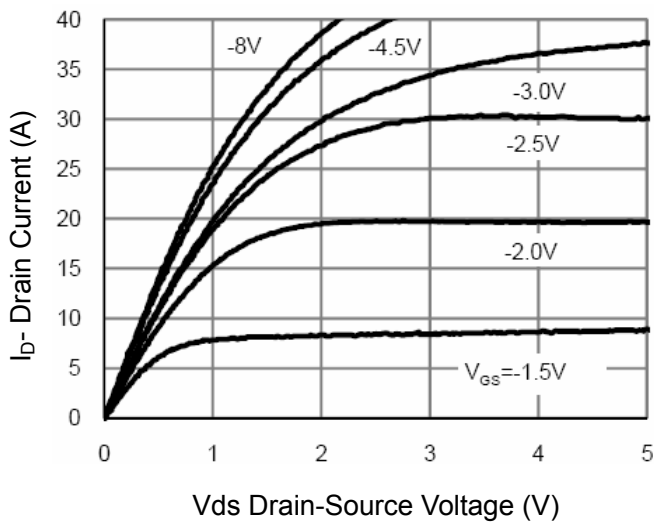

**Figure 5 Output Characteristics**

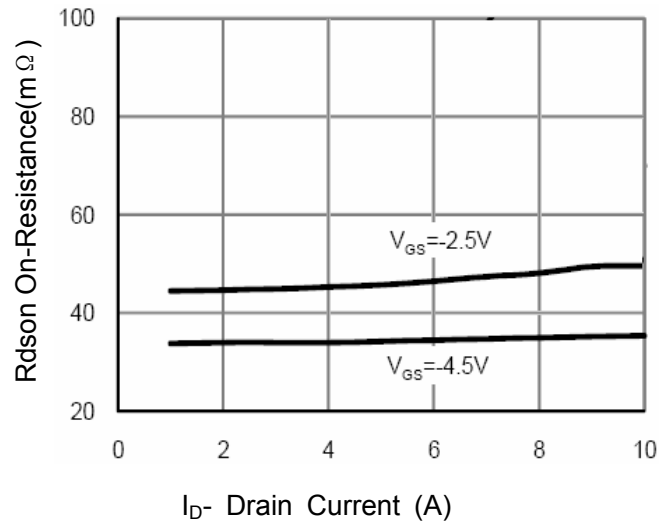

**Figure 6 Drain-Source On-Resistance**

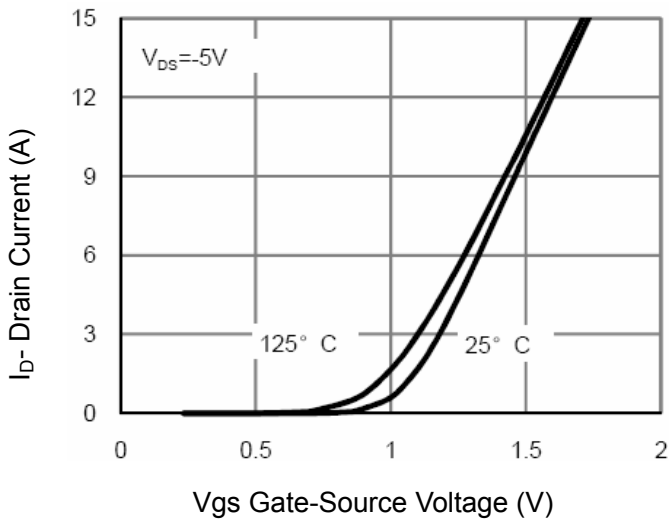

**Figure 7 Transfer Characteristics**

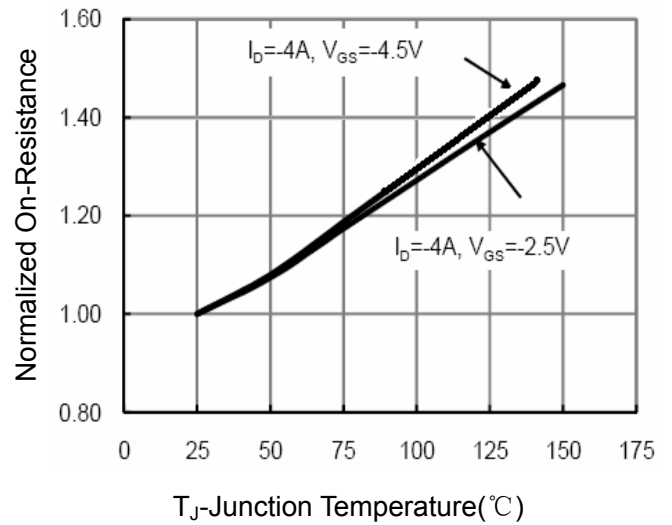

**Figure 8 Drain-Source On-Resistance**

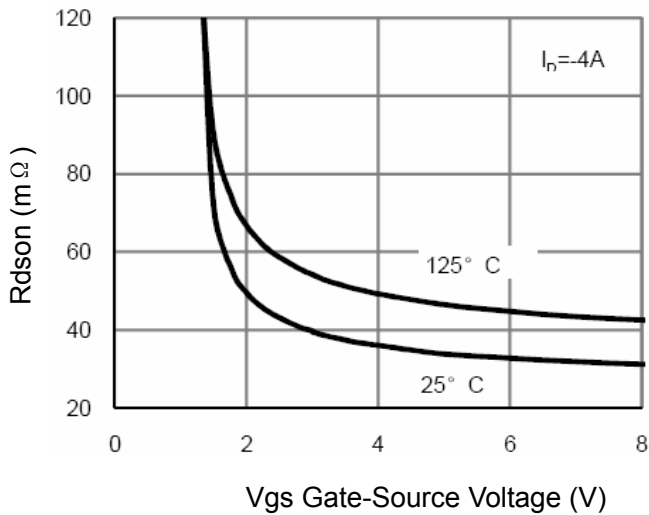

**Figure 9 Rdson vs Vgs**

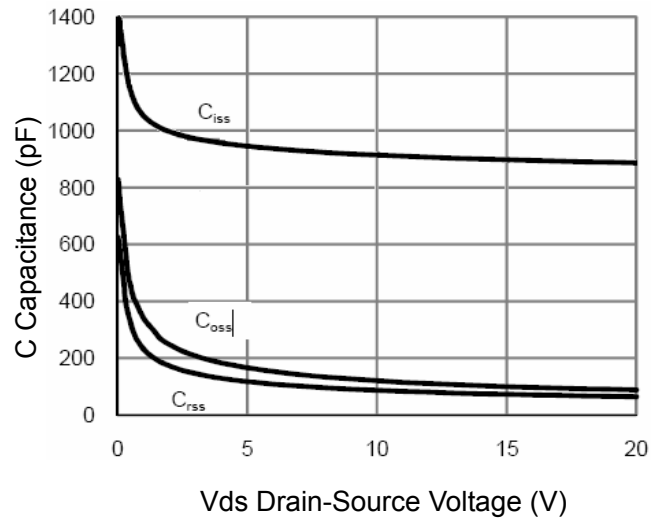

**Figure 10 Capacitance vs Vds**

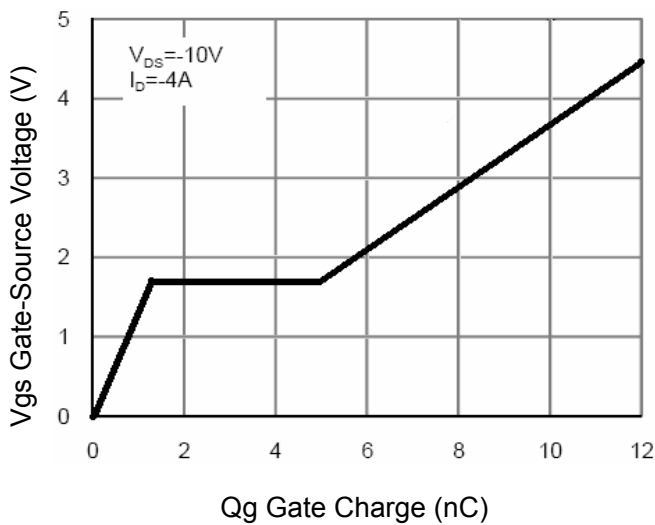

**Figure 11 Gate Charge**

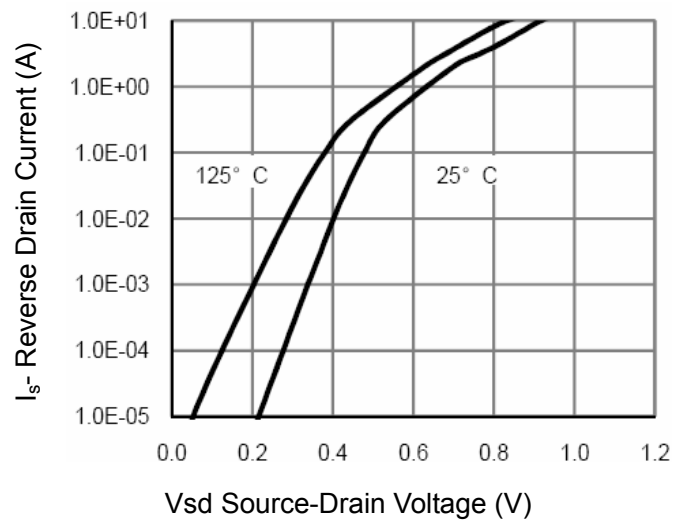

**Figure 12 Source- Drain Diode Forward**

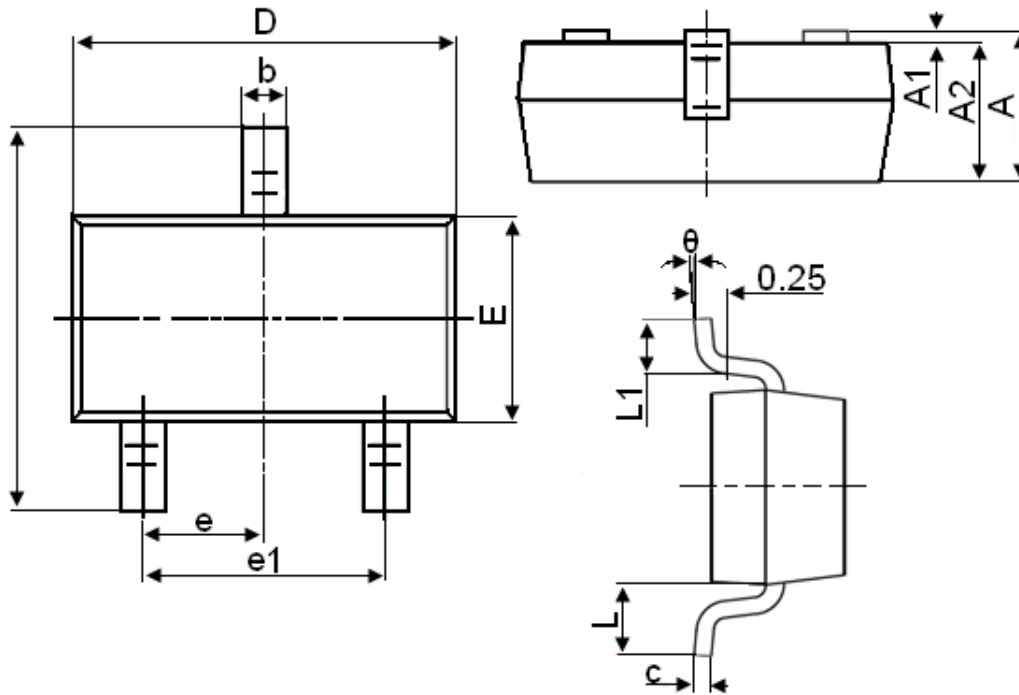
**SOT-23 Package Information**

Symbol	Dimensions in Millimeters	
	MIN.	MAX.
A	0.900	1.150
A1	0.000	0.100
A2	0.900	1.050
b	0.300	0.500
c	0.080	0.150
D	2.800	3.000
E	1.200	1.400
E1	2.250	2.550
e	0.950TYP	
e1	1.800	2.000
L	0.550REF	
L1	0.300	0.500
$\theta$	0°	8°